

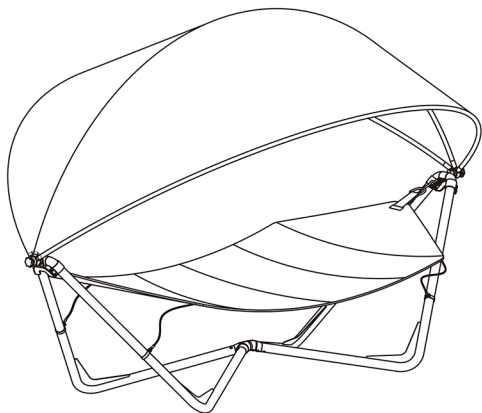























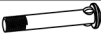



# Gondola Hammock-with sunshade



REF	PICTURE	QTY	REF	PICTURE	QTY
1		2	17		8
2		2	18		8
3		1	19		4
4		2	20		4
5		1	21		1
6		4	22		2
7		4	23		2
8		4	24		4
9		4	25		6
10		4	26		1
11		4	27		2
12		4	28		1
13		2	29		1
14		2			
15		2			
16		2			

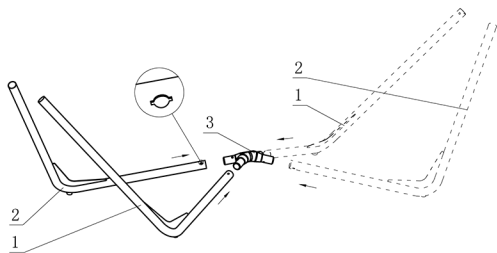

①

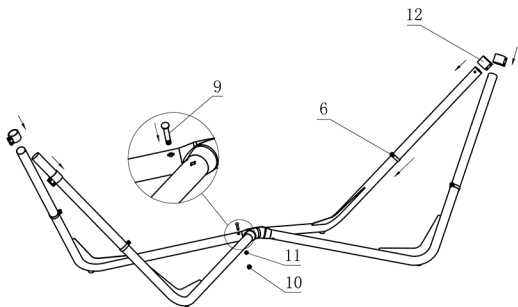

②

3

To install cover, please use No. 20 screw.  
While without cover, please use No. 19 screw.

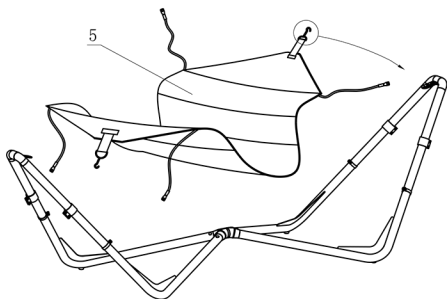
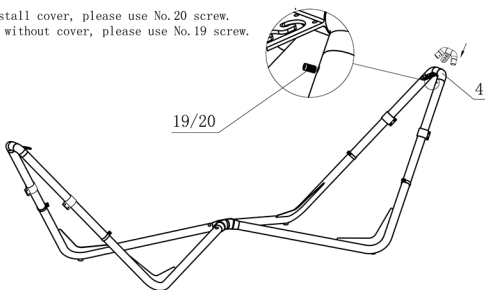

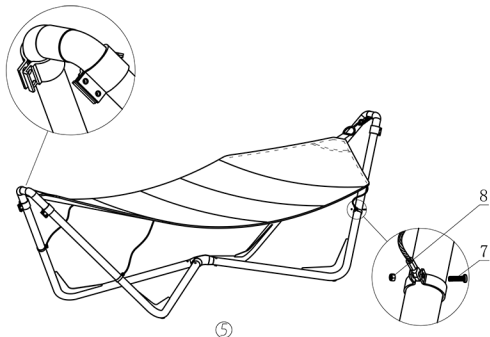

⑤

Don't tighten up 4 screws after installed. Tighten them till the gear lifted to the highest point.

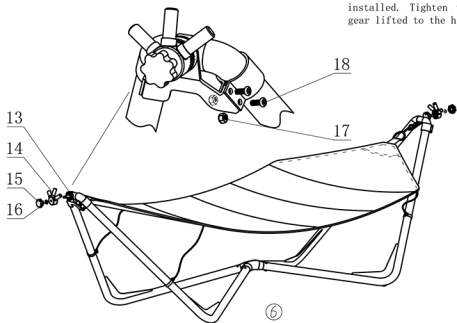

⑥

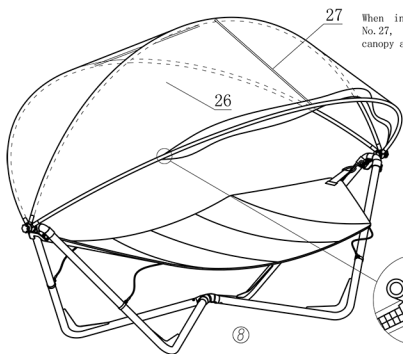
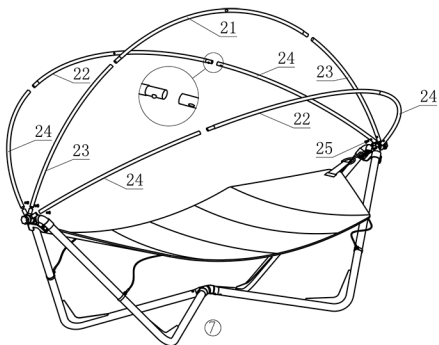

When installing the tube No.27, please tighten up canopy at the same time.

Please tighten up zippers on both sides.

