

Triangle Plastic Base

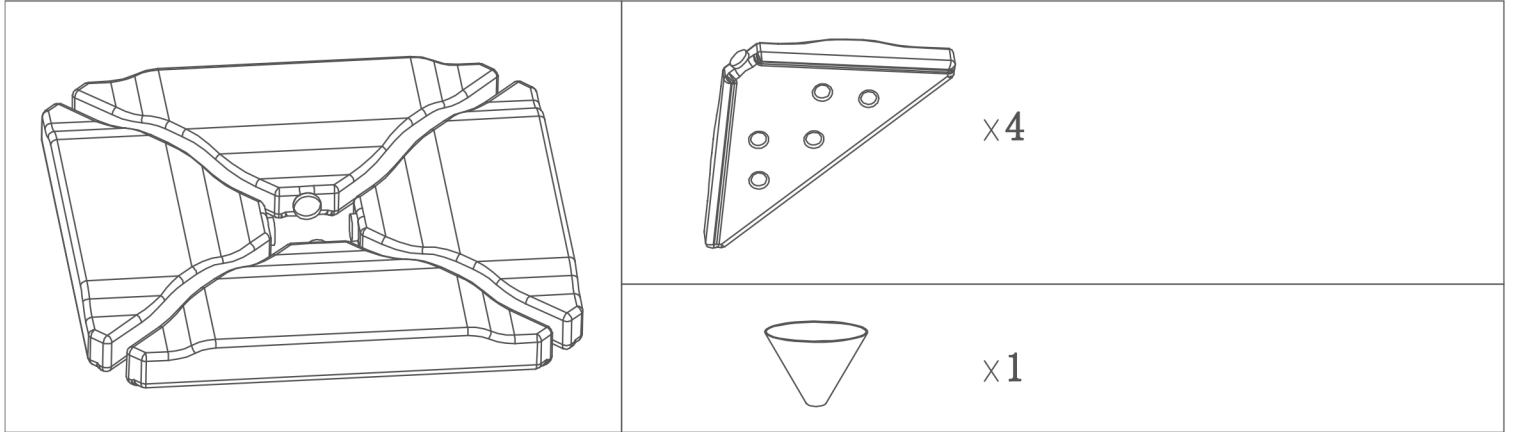
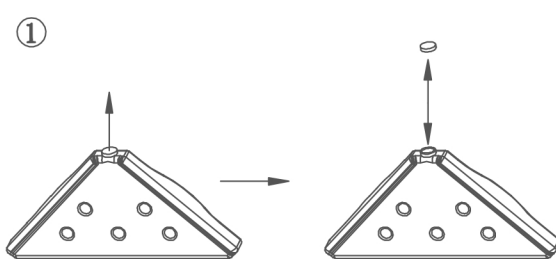
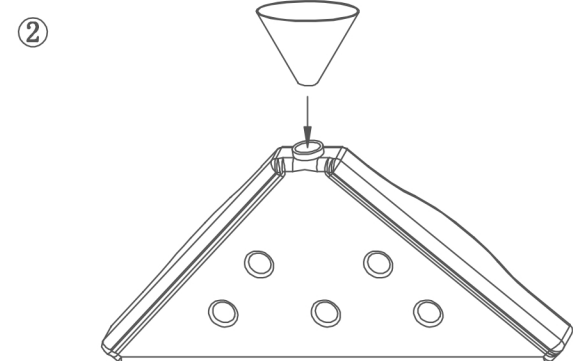

Method One

① 

② 

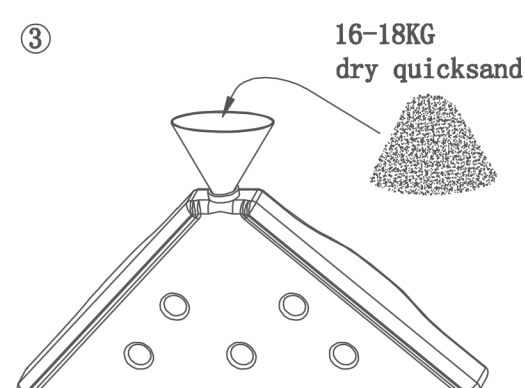
③  16-18KG dry quicksand

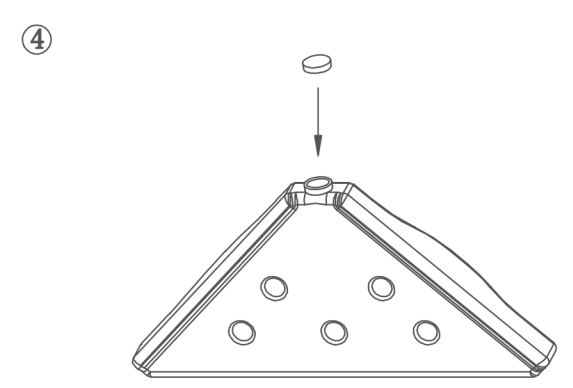
④ 

Method Two

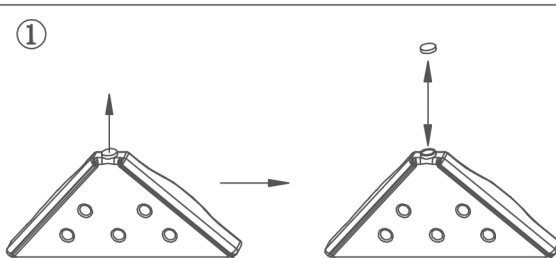
① 

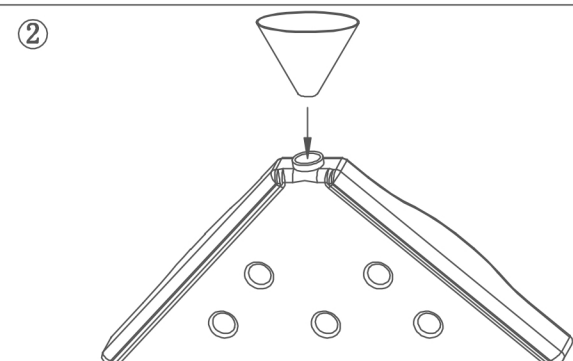
② 

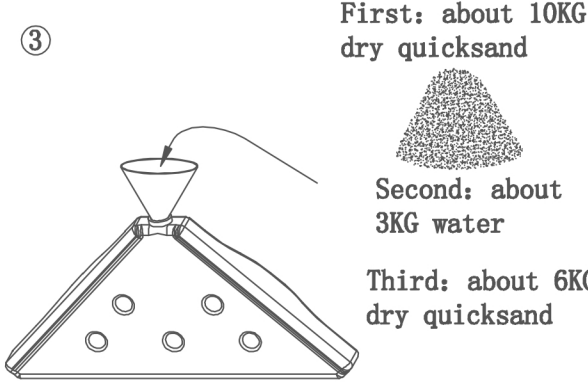
③  First: about 10KG dry quicksand
Second: about 3KG water
Third: about 6KG dry quicksand

④ 